

## 1. Description

The HAL3223 is a Latch Hall effect sensor IC fabricated from BCD technology. The device integrates a voltage regulator, Hall sensor with dynamic offset cancellation system, Schmitt trigger and an open-drain output driver with over-current protection, all in a single package.

It incorporates advanced chopper stabilization techniques to provide accurate and stable magnetic switch points. There are many applications for this sensor in addition to those listed above. The design, specifications and performance have been optimized for commutation applications in 5V to 12V brushless DC motors.

Thanks to its wide operating voltage range and extended choice of temperature range, it is quite suitable for use in automotive, industrial and consumer applications.

The device is delivered in a Small Outline Transistor (SOT) for surface mount process and in a Plastic Single In Line (TO-92 flat) for through-hole mount. Both 3-lead packages are RoHS compliant.

## 2. Product Image

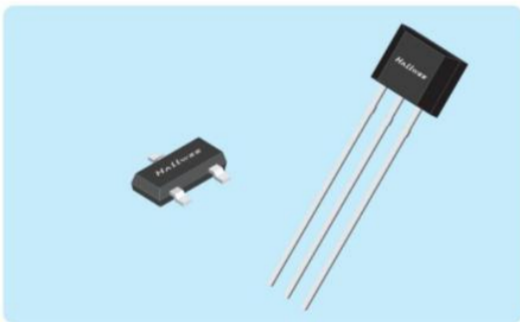

## 3. Features

- ◆ Operating voltage range from 2.8V to 24V
- ◆ High magnetic sensitivity – +/-15GS
- ◆ BCD technology
- ◆ -28V Reversed Power Supply Protection
- ◆ -40°C~150°C Operating Temperature
- ◆ Output Limiting Current Protection
- ◆ Output driver with internal pull-up resistor
- ◆ ESD 4KV

## 4. Applications

- ◆ Automotive, Consumer and Industrial
- ◆ Solid-state switch
- ◆ Brushless DC motor commutation
- ◆ Speed detection
- ◆ Linear position detection
- ◆ Angular position detection
- ◆ Proximity detection

## 5. Functional Block Diagrams

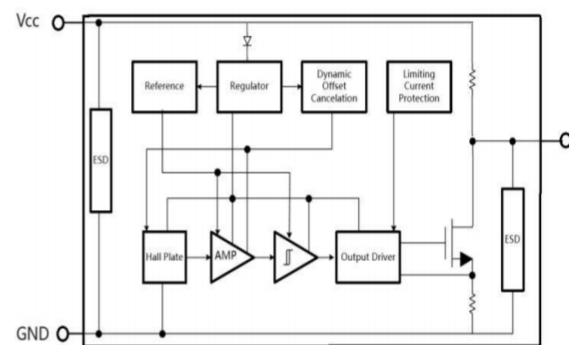

## 6. Pin Definitions and Descriptions

SO Pin No.	UA Pin No.	Name	Type	Function
1	1	V <sub>DD</sub>	Supply	Supply Voltage Pin
2	3	OUT	Output	Open Drain Output Pin
3	2	GND	Ground	Ground Pin



## 7. Detailed General Description

The HAL3223 exhibits latch magnetic switching characteristics. Therefore, it requires both south and north poles to operate properly.

The OUT pin of these devices switches low (turns on) when a magnetic field perpendicular to the Hall sensor exceeds the operate point threshold, B<sub>OP</sub>. After turn-on, the output voltage is V<sub>DSon</sub>. Note that the device

latches, that is, a North pole of sufficient strength towards the branded surface of the device turns the device on. The device remains on if the North pole is removed ( $B \rightarrow 0$ ). This latching property defines the device as a magnetic memory.

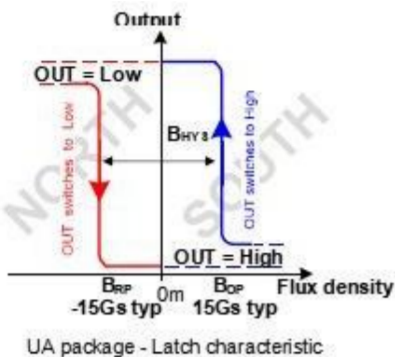

When the magnetic field is reduced below the release point,  $B_{RP}$ , the OUT pin turns off (goes high). The difference in the magnetic operate and release points is the hysteresis,  $B_{HYS}$ , of the device. This built-in hysteresis prevents output oscillation near the switching point, and allows clean switching of the output even in the presence of external mechanical vibration and electrical noise.

The device behaves as a latch with symmetric operating and release switching points ( $B_{OP} = |B_{RP}|$ ). This means magnetic fields with equivalent strength and opposite direction drive the output high and low.

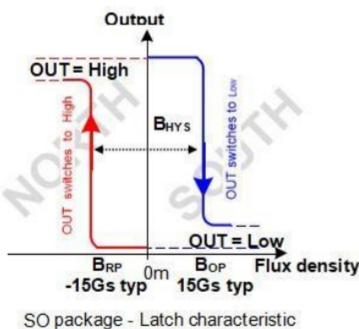

Powering-on the device in the hysteresis region (less than  $B_{OP}$  and higher than  $B_{RP}$ ) allows an indeterminate output state. The correct state is attained after the first excursion beyond  $B_{OP}$  or  $B_{RP}$ .

The SOT-23 device is reversed from the UA package. The SOT-23 output transistor will be latched on in the presence of a sufficiently strong South pole magnetic field applied to the marked face.

### 8. Unique Features

Based on BCD technology, InnoSen HAL3223 is a Hall-effect device with high magnetic sensitivity. This multi-purpose latch suits most of the application requirements.

The chopper-stabilized amplifier uses switched capacitor technique to suppress the offset generally observed with Hall sensors and amplifiers. The CMOS technology makes this advanced technique possible and contributes to smaller chip size and lower current consumption than bipolar technology. The small chip size is also an important factor to minimize the effect of physical stress. This combination results in more stable magnetic characteristics and enables faster and more precise design.

The operating voltage from 2.8V to 24V, low current consumption and large choice of operating temperature range according to "L", and "E" specification make this device suitable for automotive, industrial and consumer applications.

### 9. Absolute Maximum Ratings

Parameter	Symbol	Value	Units
Supply Voltage	$V_{DD}$	42	V
Reverse Battery Voltage	$V_{RCC}$	-42	mA
Output Voltage	$V_{OUT}$	42	V
Continuous Output Current	$I_{OUT}$	30	mA
Operating Temperature Range	$T_O$	-40 ~ 150	$^{\circ}C$
Storage Temperature Range	$T_S$	-50 ~ 150	$^{\circ}C$
Maximum Junction Temperature	$T_J$	165	$^{\circ}C$
Output clamp current	$I_{ocp}$	60	mA
The electrostatic capacity	ESD	4	KV

Operating Temperature Range	Symbol	Value	Units
Temperature Suffix "E"	$T_A$	-40 ~ 85	$^{\circ}C$
Temperature Suffix "L"	$T_A$	-40 ~ 150	$^{\circ}C$

**Note:** Exceeding the absolute maximum ratings may cause permanent damage. Exposure to absolute-maximum-rated conditions for extended periods may affect device reliability.

## 10. General Electrical Specifications

 DC Operating Parameters  $T_a = 25^{\circ}\text{C}$ ,  $V_{DD} = 2.8\text{V to } 24\text{V}$ 

Parameter	Symbol	Test Conditions	Min	Typ	Max	Units
Supply Voltage	$V_{DD}$	Operating	2.8		24	V
Supply Current	$I_{DD}$	$B < B_{RP}$		3	5	mA
Output Saturation Voltage	$V_{DSon}$	$I_{OUT} = 20\text{mA}$ , $B > B_{OP}$			0.5	V
Output Leakage Current	$I_{OFF}$	$B < B_{RP}$ , $V_{OUT} = 24\text{V}$		<1	10	$\mu\text{A}$
Output Rise Time	$T_R$	$R_L = 1\text{K}\Omega$ , $C_L = 20\text{pF}$		0.25		$\mu\text{s}$
Output Fall Time	$T_F$	$R_L = 1\text{K}\Omega$ , $C_L = 20\text{pF}$		0.25		$\mu\text{s}$
Internal pull-up resistor	$R_{PU}$		9	12	15	K $\Omega$
Maximum Switching Frequency	$F_{SW}$			10		KHz
Package Thermal Resistance	$R_{TH}$	Single layer (1S) JEDEC board		301		$^{\circ}\text{C/W}$

## 11. Magnetic specification

 DC Operating Parameters:  $T_A = 25^{\circ}\text{C}$ ,  $V_{DD} = 5\text{V} \sim 24\text{V}$ , UA Package

Parameter	Sym	Min	Typ	Max	Units
Operating Point	$B_{OP}$	10	15	30	Gs
Release Point	$B_{RP}$	-30	-15	-10	Gs
Hysteresis	$B_{HYS}$	20	30	40	Gs

## 12. Output Behavior versus Magnetic Pole

 DC Operating Parameters:  $T_A = -40^{\circ}\text{C} \sim 150^{\circ}\text{C}$ ,  $V_{DD} = 2.8\text{V} \sim 24\text{V}$ 

Parameter	Test Conditions (UA)	OUT (UA)	Test Conditions (SO)	OUT (SO)
South pole	$B < B_{RP}$	High	$B > B_{OP}$	Low
North pole	$B > B_{OP}$	Low	$B < B_{RP}$	High

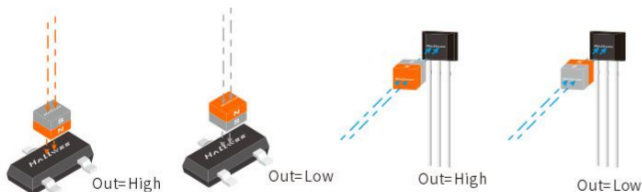

## 13. Application Information

It is strongly recommended that an external bypass capacitor be connected (in close proximity to the Hall sensor) between the supply ( $V_{DD}$  Pin) and

ground (GND Pin) of the device to reduce both external noise and noise generated by the chopper stabilization technique. As is shown in the two figures in next page, a  $0.1\mu\text{F}$  capacitor is typical.

For reverse voltage protection, it is recommended to connect a resistor or a diode in series with the  $V_{DD}$  pin. When using a resistor, three points are important:

### Typical Three-Wire Application Circuit

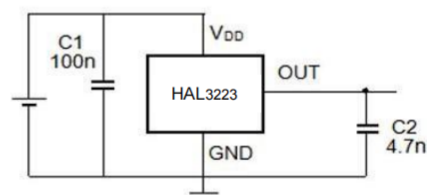

### Performance Characteristics

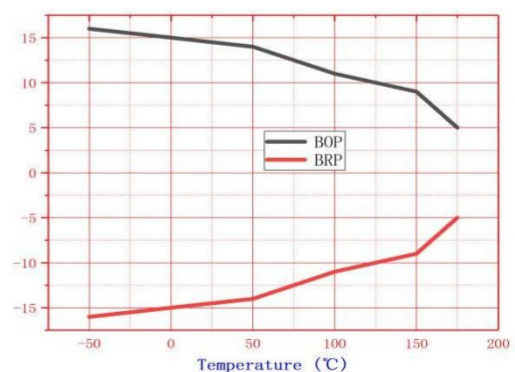

## 14. Package Information

### 14.1. UA Package(TO-92S flat)

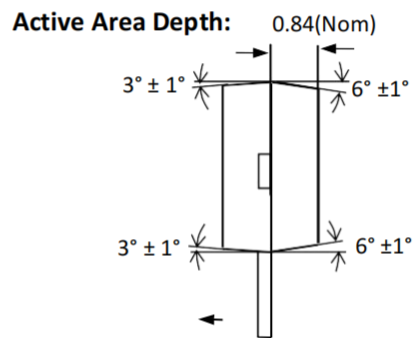
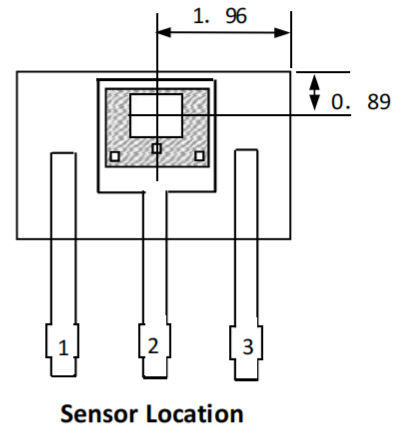
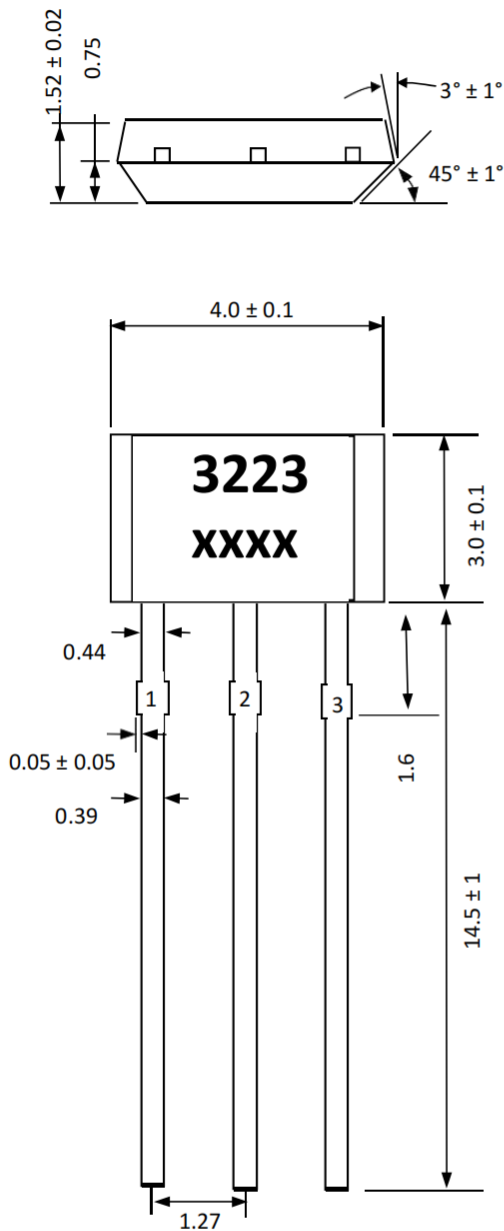

#### Notes:

- 1). Controlling dimension: mm;
- 2). Leads must be free of flash and plating voids;
- 3). Do not bend leads within 1 mm of lead to package interface;
- 4). PINOUT: Pin 1  $V_{DD}$

Pin 2 GND

Pin 3 Output

#### Marking:

3223 -- Code of Device (HAL3223);

XXXX -- Production Lot;

14.2. SO Package(SOT23-3L)

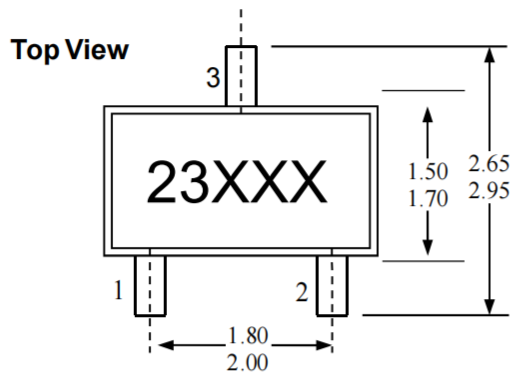

Notes:

- 1). PINOUT: Pin 1 V<sub>DD</sub>  
Pin 2 Output  
Pin 3 GND
- 2). All dimensions are in millimeters;

Marking:

- 23 -- Code of Device (HAL3223);
- XXX -- Production Lot;

Side View

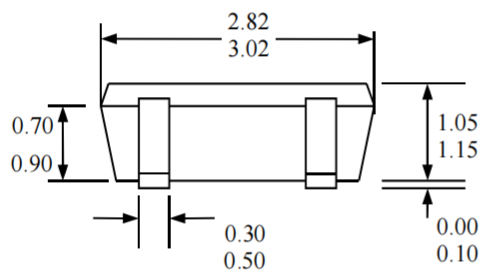

End View

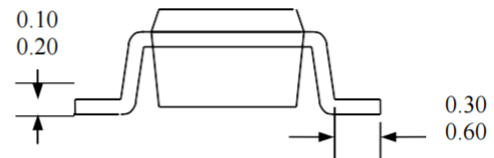

Bottom View of SOT-23 Package

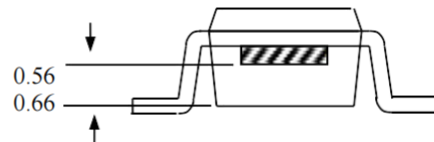
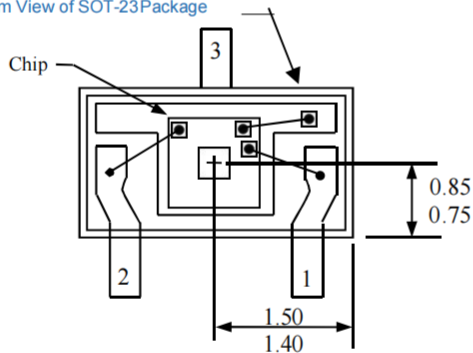

15. Ordering Information

Part No.	Temperature Suffix	Package Code
HAL3223	E (-40°C ~ 85°C)	SO (SOT23-3L)
		UA (TO-92S)
	L (-40°C ~ 150°C)	SO (SO23T-3L)
		UA (TO-92S)